

NCS NATIONAL
CEILING
SYSTEMS

A stylized orange line representing a seismic wave, starting with a large initial peak on the left, followed by several smaller, irregular oscillations that extend across the bottom of the page.

SEISMIC
DESIGN GUIDE



CONTENTS

- 01** Introduction
- 02** The process
- 03** Guide limitations & assumptions
- 04** Seismic design application
- 05** Seismic bracing configurations
- 06** Perimeter details & diagrams
- 07** Main tee & cross tee seismic joint clip
- 08** Back-bracing details
- 09** Trims & accessories
- 10** Integration of services

THE PURPOSE OF THIS GUIDE

This guide is intended to provide basic information which will support the installation of National Ceiling Systems' suspended exposed grid and tile ceilings in accordance with the requirements of AS 1170.4 and NZS 1170.5 – Structural Design Actions – Earthquake Actions.

In the event of an earthquake, the failure of suspended ceilings not installed to proper seismic standards can result in significant injury or loss of life.

In addition to seismic events, other industries with comparable risks (i.e. blasts and vibrations) could benefit from seismic ceiling design. These include:

- Defence buildings
- Chemical facilities
- Transport facilities (vibrations)
- Power generation plants

All National Ceiling Systems seismic designs are developed in accordance with the following standards:

- AS/NZ 2785: 2020 Suspended Ceiling – Design and installation
- AS1170.4: 2007 Structural Design Actions – Earthquake actions in Australia
- AS1170.5: 2009 Structural Design Actions – Earthquake actions in New Zealand
- NZS 4219: 2009 Seismic Performance Of Engineering Systems In Buildings

THE PROCESS

The seismic design of non-structural elements (like the ceilings) for any project should ideally be completed prior to the tender process. Those responsible for the seismic design must specify the required grade of the ceiling, as well as the bracing layout, perimeter details, services layout and suspension points.

It is recommended that the seismic design is conducted in collaboration with the design of other components above the ceiling, for example, mechanical services, lighting and fire systems; and ideally in conjunction with the concealed ceiling and partition wall design. This will ensure that the ceiling fits together as a whole without on-site variations and delays, and that the seismic capabilities of the ceiling are not compromised by other services.

GUIDE LIMITATIONS

This guide only takes into consideration the Trident exposed grid systems, installed in a normal horizontal plane.

This guide is applicable to ceilings with a drop of 1200mm or less from the substrate. If the drop is longer than 1200mm, an engineer should be engaged.

This is a guide only, and is not any type of certification or design.

Braced ceiling systems are shown in standard rectangular configurations. Situations with more complex configurations require guidance from a structural engineer.

Back braced configurations do not apply where only one main tee is installed. Again, guidance from a structural engineer is recommended.

A structural engineer must be consulted in the event that the building has importance level 4, as these buildings must be operational immediately following a seismic event (e.g., hospitals, triage centres and emergency shelters); and therefore are subject to more stringent requirements which cannot be covered by a guide.

ASSUMPTIONS

No partition walls are braced to ceiling grid, unless specifically designed and engineered.

Standard service load as per AS/NZ 2785 Section 2.2.2 – 3.2kg/m².

Other suspended items more than 7.5kg are independently suspended and braced, and do not interfere with the grid structure unless specifically designed and engineered.

Fixed and Floating drawings (pages 9-11) assume ceiling grid runs perpendicular to the wall.

At a fixed perimeter, the external structure is capable of withstanding the line load applied by the ceiling.

Back bracing is installed in line with the relevant manufacturer's specification.

Installation and design is in accordance with the information provided in this brochure.

To reduce the risk of differential displacements, ceilings should not be secured to two opposite walls without a seismic gap.

SEISMIC DESIGN APPLICATION

National Ceiling Systems can provide a seismic design for a project, based on details provided in our Seismic Design Application form. Access to the form is via our website, nationalcs.com.au.

When submitting the application, include the following:

1. Hazard factor (Z) - based on region, can be confirmed with address.
2. Site sub-soil
3. Importance level
4. Design life (normally 50 years)
5. Building height and finished ceiling height
6. Ceiling tile type and weight
7. Grid type and layout
8. Main tee layout
9. Services layout, and (a) if these are being installed as per seismic requirements; or (b) confirmation that all services are independently supported and not relying on the ceiling grid system for support.
10. Drawings (RCPs, elevations, partition plans and schedules; and any other relevant details. Include structural notes showing importance level).

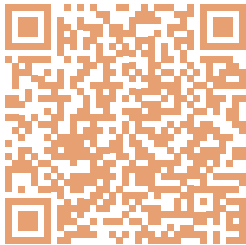

Scan to access the NCS seismic design application form.

CONSIDERATIONS

Engaging a structural engineer should always be considered for any type of project.

The project engineer must review all information supplied with a seismic design from NCS to ensure its compatibility and applicability to the project.

Any seismic design presented by NCS is not a certified design as per Form 15 or other relevant requirements, and can not be used as such before discussion with an engineer.

SEISMIC BRACING

This section of the guide details three configurations for bracing an exposed grid ceiling.

Two of these configurations utilise the Fixed and Floating perimeter connection method, while the third involves Back Bracing to the structure above the ceiling.

FIXED & FLOATING

SRIC clips at all ceiling-perimeter connections, forcing lateral load to be transferred from the ceiling to the perimeter through this fixing. This system is braced to the wall and therefore the wall must be built so as to handle the load.

Partitions should be checked to ensure they can handle the load transfer. This configuration cannot be used for rooms larger than 10 metres in any direction.

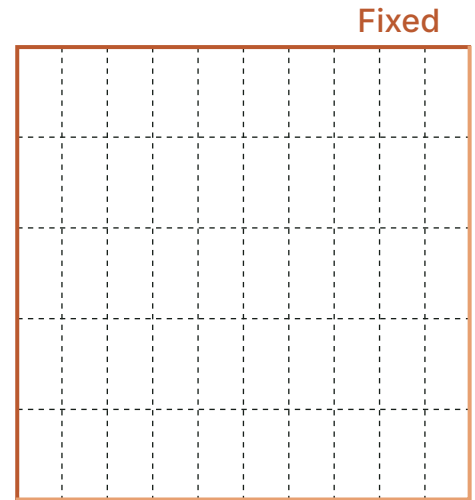

Floating

FIXED WITH JOINTS

Perimeter fixed on all four sides, and the ceiling area divided into smaller sections with seismic joints.

Perimeter fixed with SRIC clips, whereby lateral load is transferred to the perimeter of the area. Stud wall must have noggins at the finished ceiling height to ensure secure connection.

This is common with larger ceiling plenums; however, cannot be used where the distance between the perimeter and seismic joint is more than 10 metres.

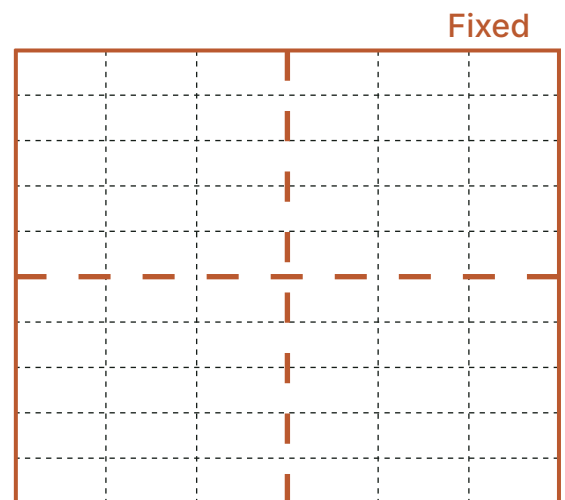

FLOATING & BACK-BRACED

Perimeter is floating on all four sides, and ceiling is braced back to the structure above (bracing supports marked with X) with compression struts or diagonal compression struts.

This is most common for larger areas.

In Australia, bracing must be no greater than 9 × 9m.

In NZ, bracing must be no greater than 6 × 6m.

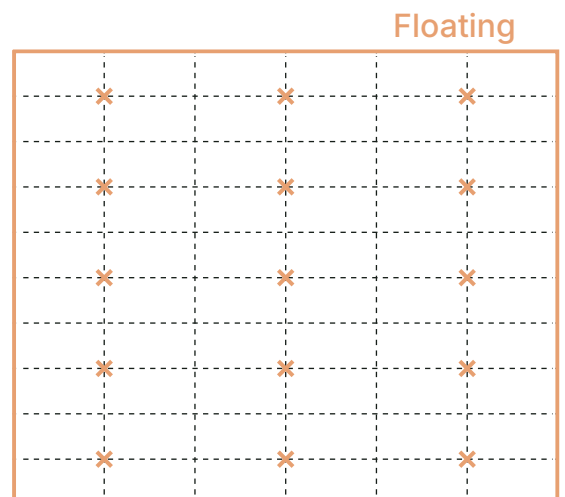



PERIMETER OPTIONS

PERIMETER (FIXED & FLOATING)

For configurations Fixed & Floating and Fixed with Joints, consider the following:

- Type of perimeter trim
- SRIC clip
- Clearance and overlap: On two adjacent walls, a 19mm clearance between the vertical of the perimeter trim and a 6mm overlap of the grid on the trim is required.

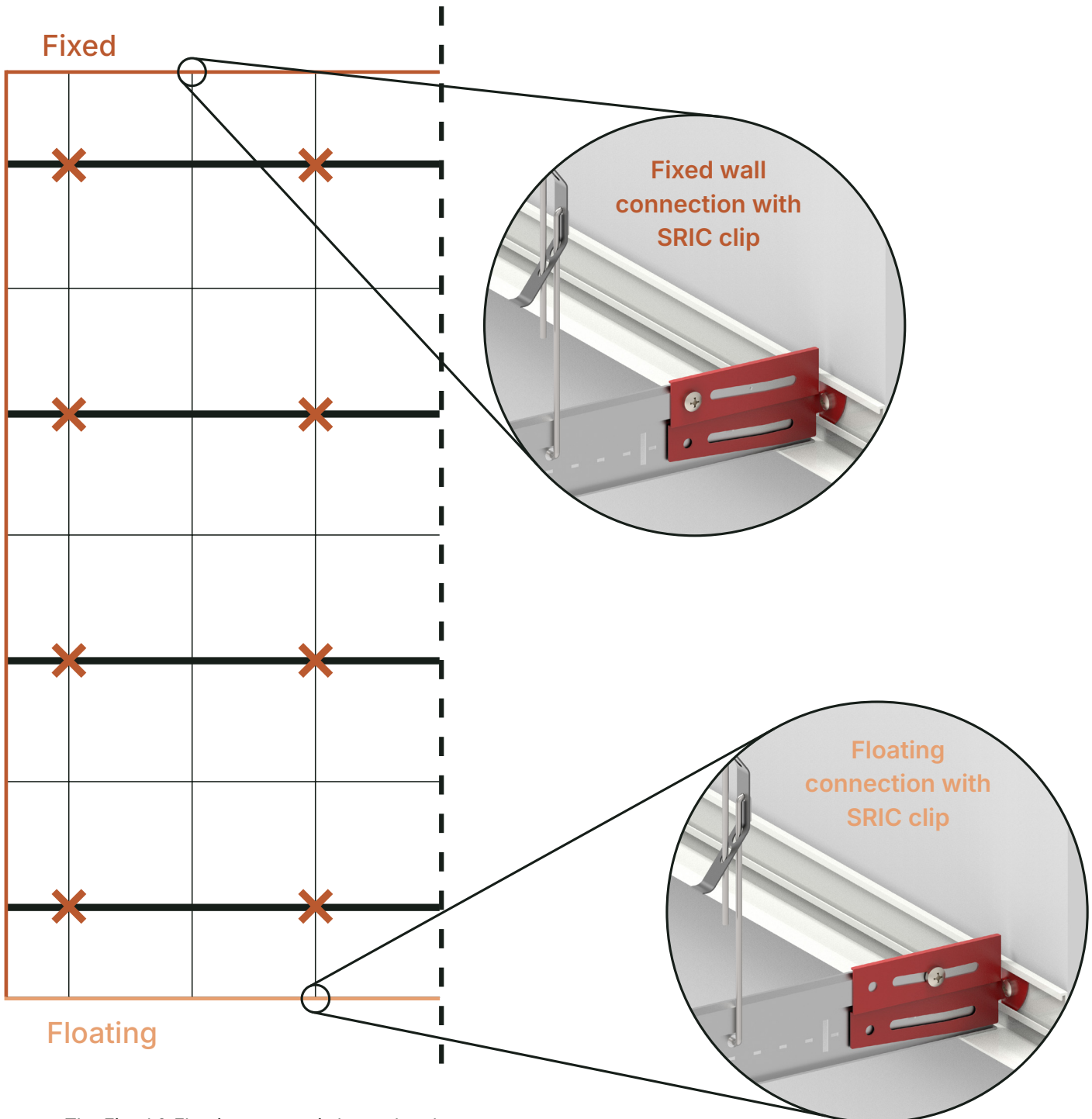

The Fixed & Floating system is braced to the wall, and the wall must be able to handle the load. For ceilings with large drops, this may not be suitable.

PERIMETER DIAGRAMS

FLOATING CONNECTION: PLAIN WALL ANGLE

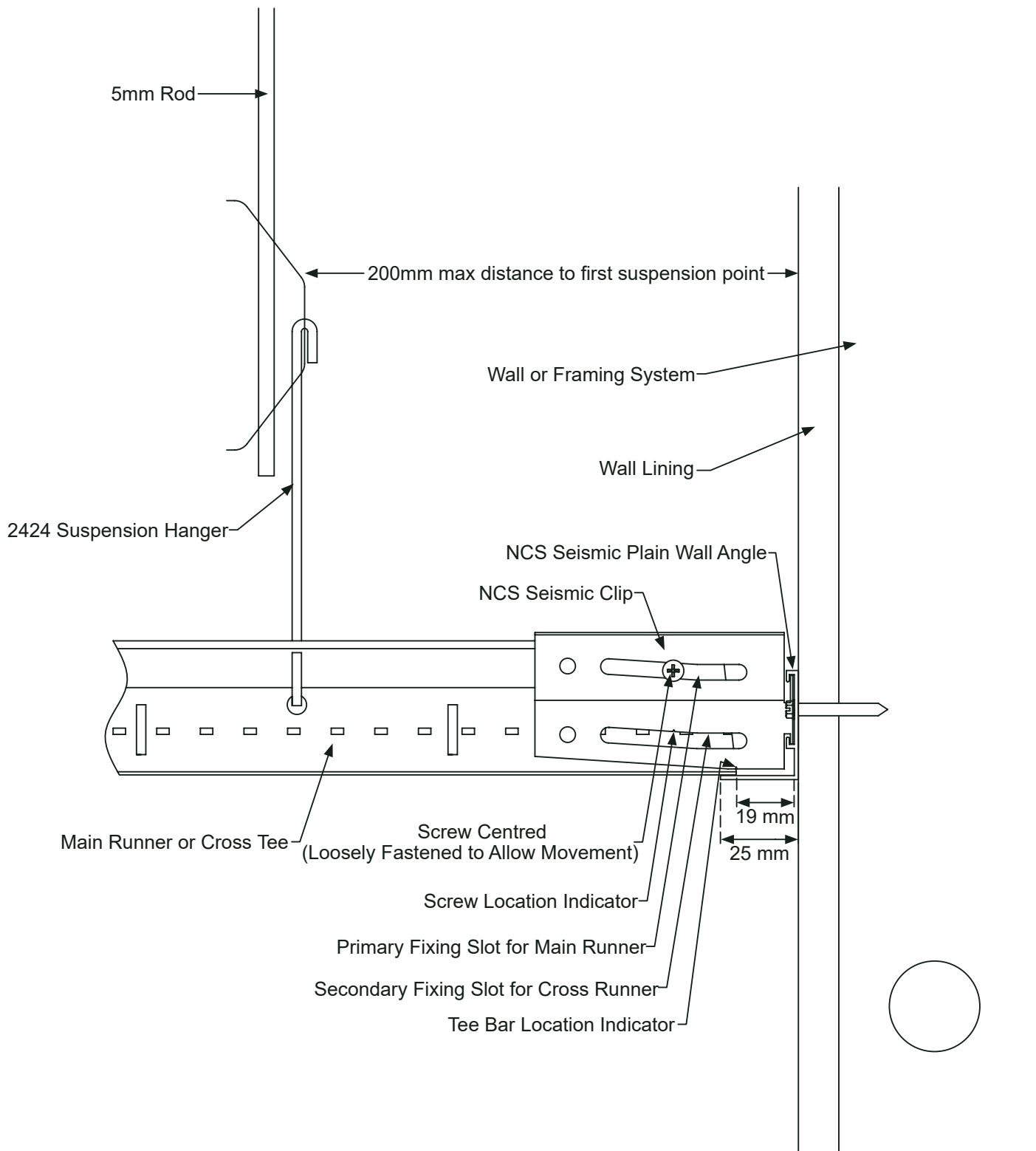

PERIMETER DIAGRAMS

FIXED CONNECTION: PLAIN WALL ANGLE

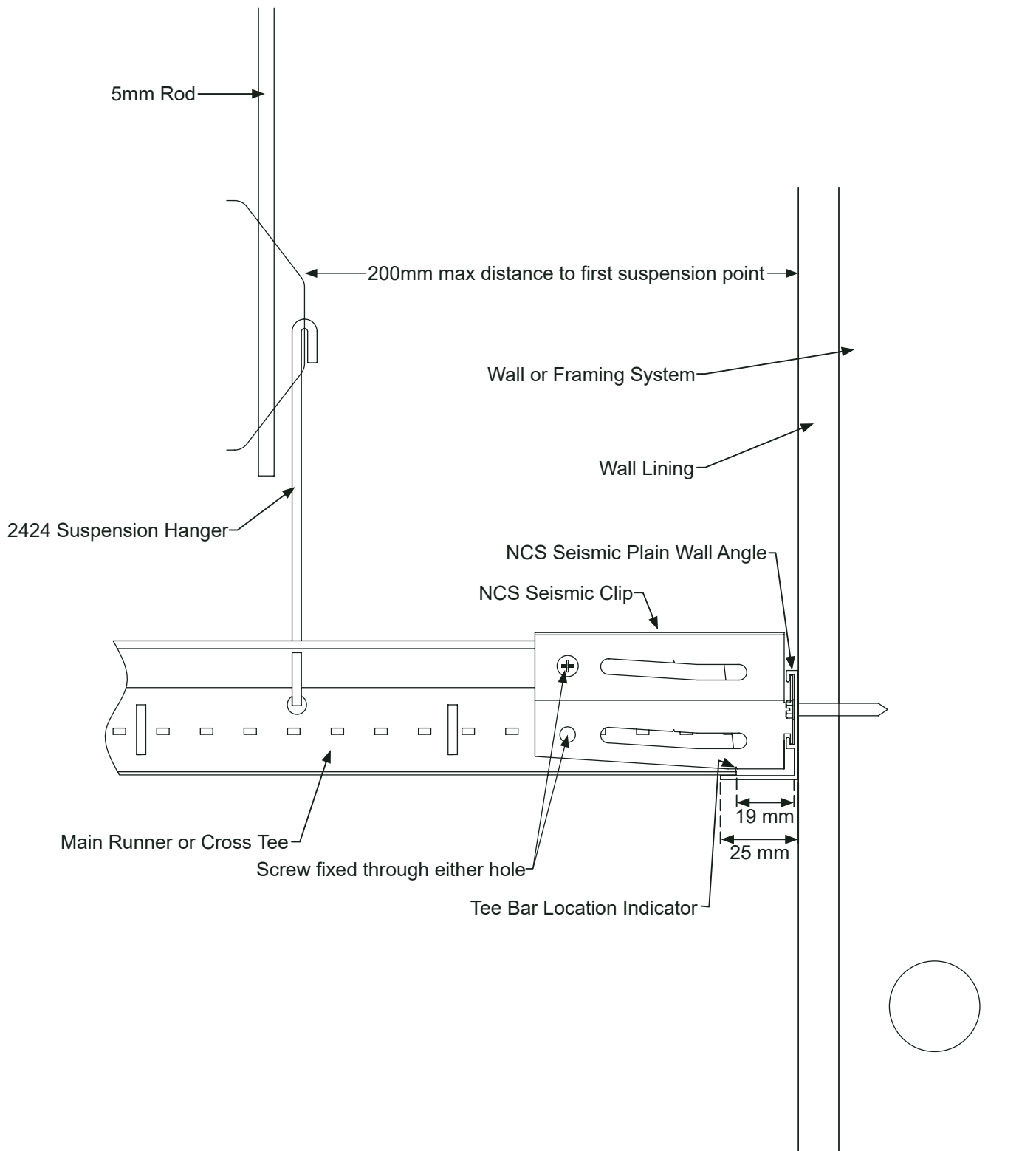

PERIMETER DIAGRAMS

FLOATING CONNECTION: SHADOWLINE WALL ANGLE

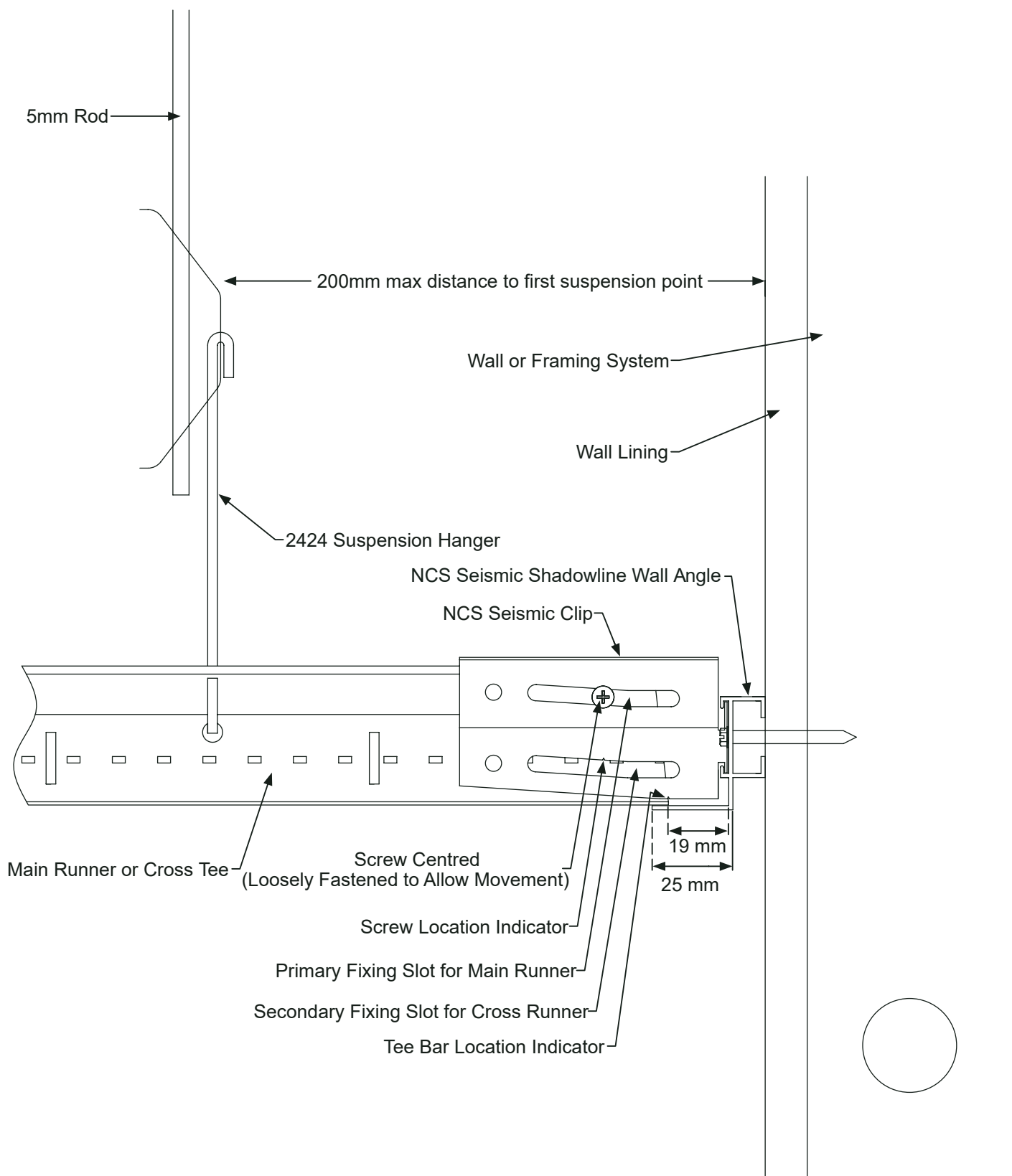

PERIMETER DIAGRAMS

FIXED CONNECTION: SHADOWLINE WALL ANGLE

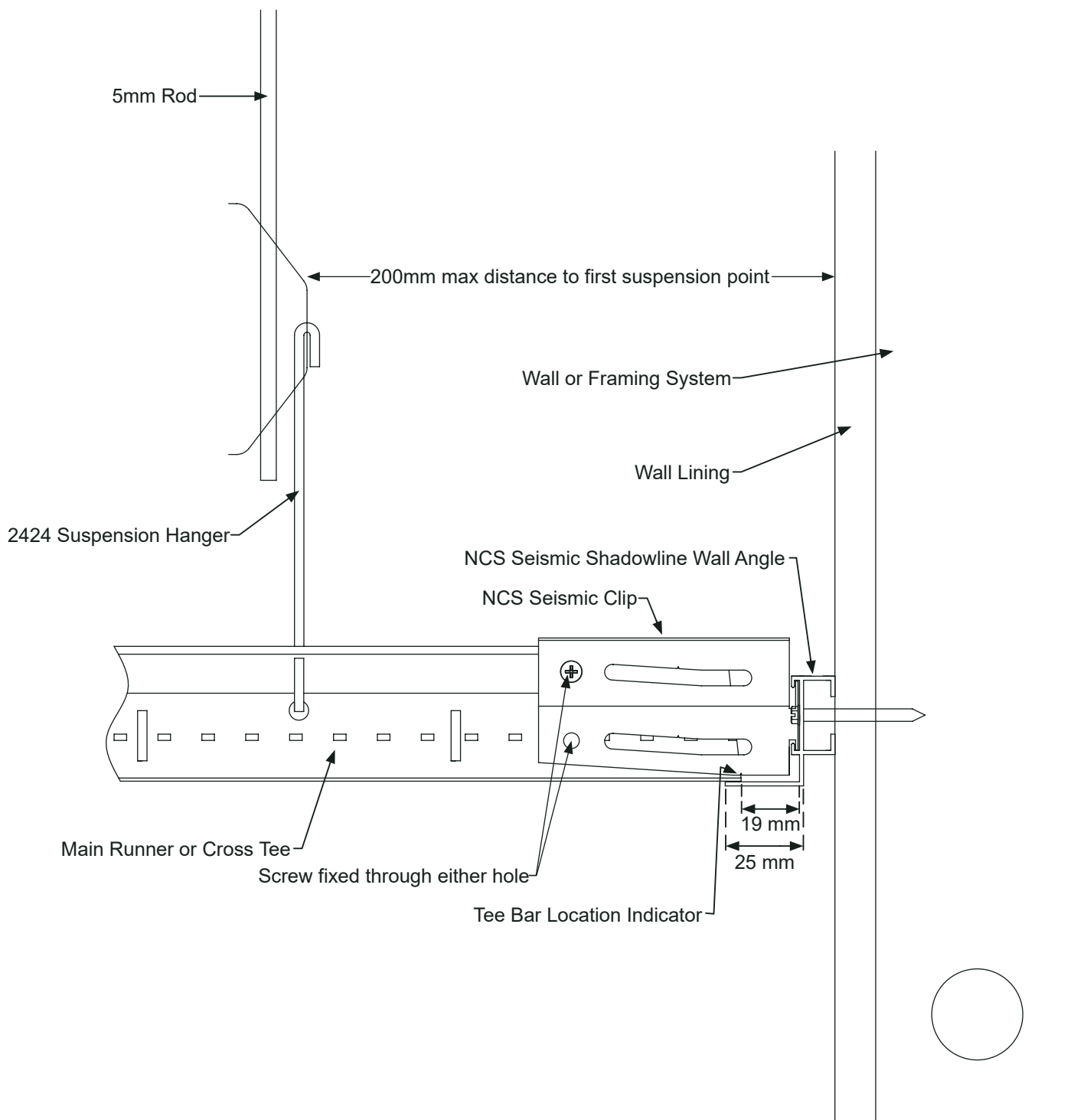

MAIN TEE SEISMIC JOINT CLIP

This section of the guide details the installation of seismic joints on main tees, by way of separation clips, as per Configuration Two (see page 6).

1. Begin by installing the grid system. All main tee joints must align across the ceiling.
2. Cut the hook from the end of the first main tee, on the left-hand side. Remove 20mm from the main tee on the right-hand side.
3. Slide two joint clips together and install with provided screws as per diagram.
4. Clip an expansion sleeve over the join in the face of the two main tees, and use pliers to secure.

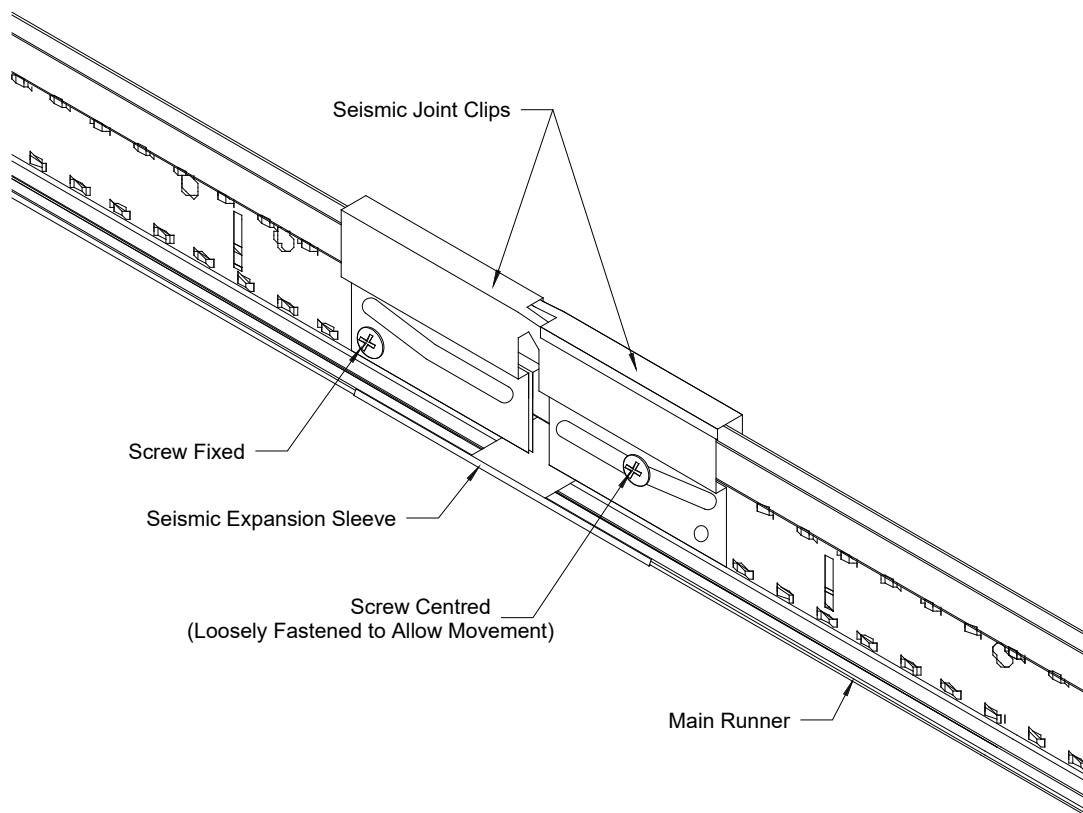

Seismic joint clips
Installed in accordance with design

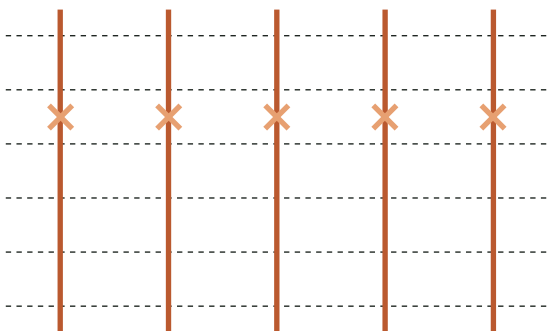

CROSS TEE SEISMIC JOINT CLIP

This section of the guide details the installation of seismic joints on cross tees, by way of separation clips, as per Configuration Two (see page 6).

1. Begin by installing the grid system as per installation instructions provided separately.
2. Ascertain which main tee run will form the seismic joint and attach two adjacent sides to the perimeter (see page 6, Configuration Two).
3. Cut hooks from both cross tees at each intersection.
4. Slide two joint clips together and install with provided screws as per diagram.

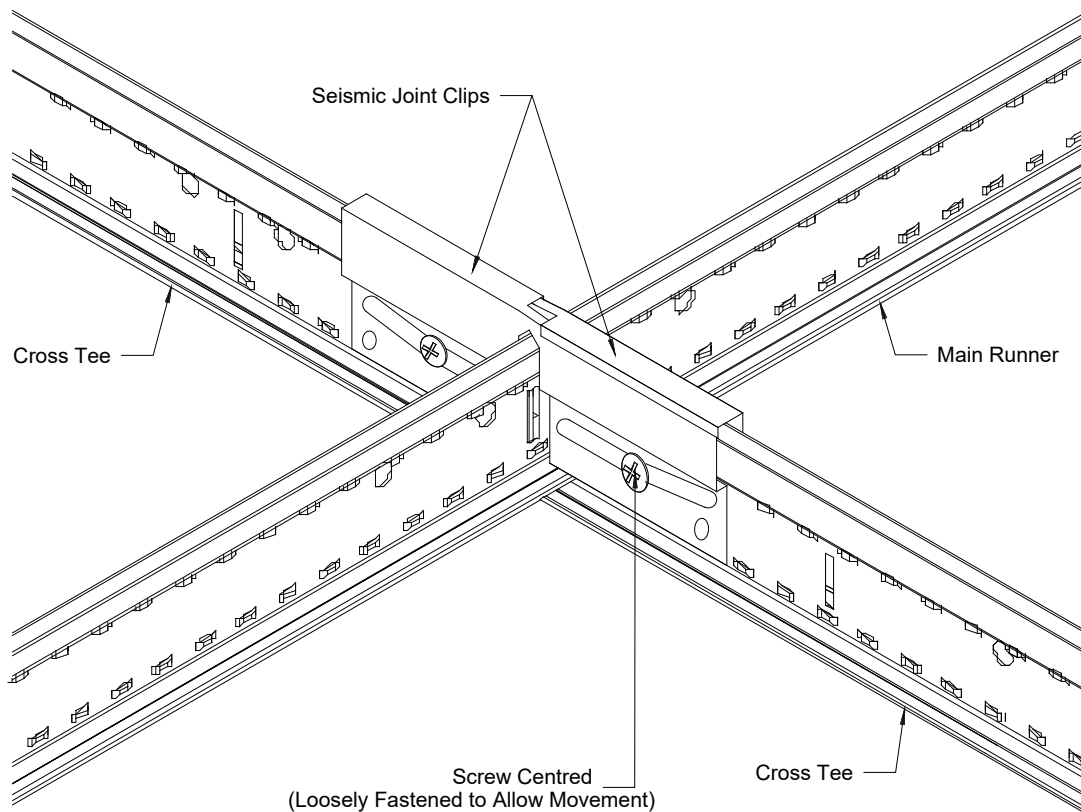

Seismic cross tee joint clips
Installed in accordance with design

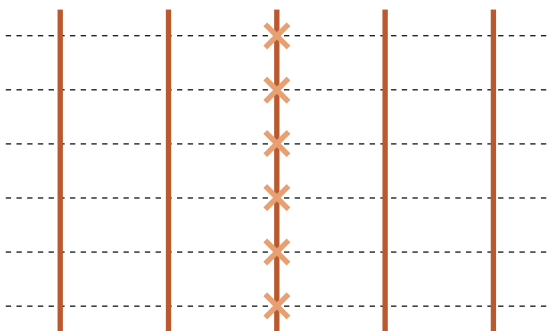

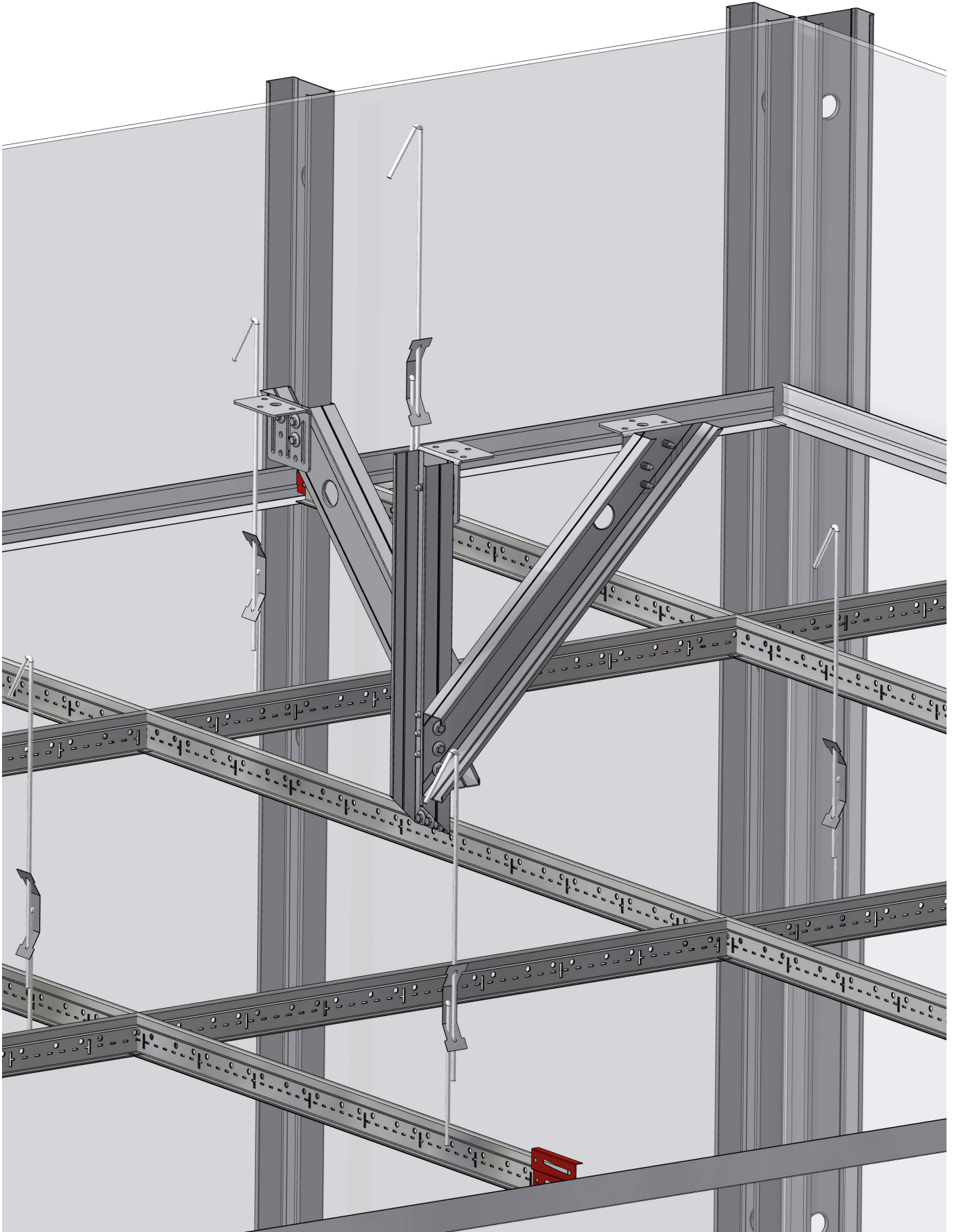

BACK-BRACING DETAILS

BACK-BRACING

STANDARD CONNECTION DETAILS

Fig. 1

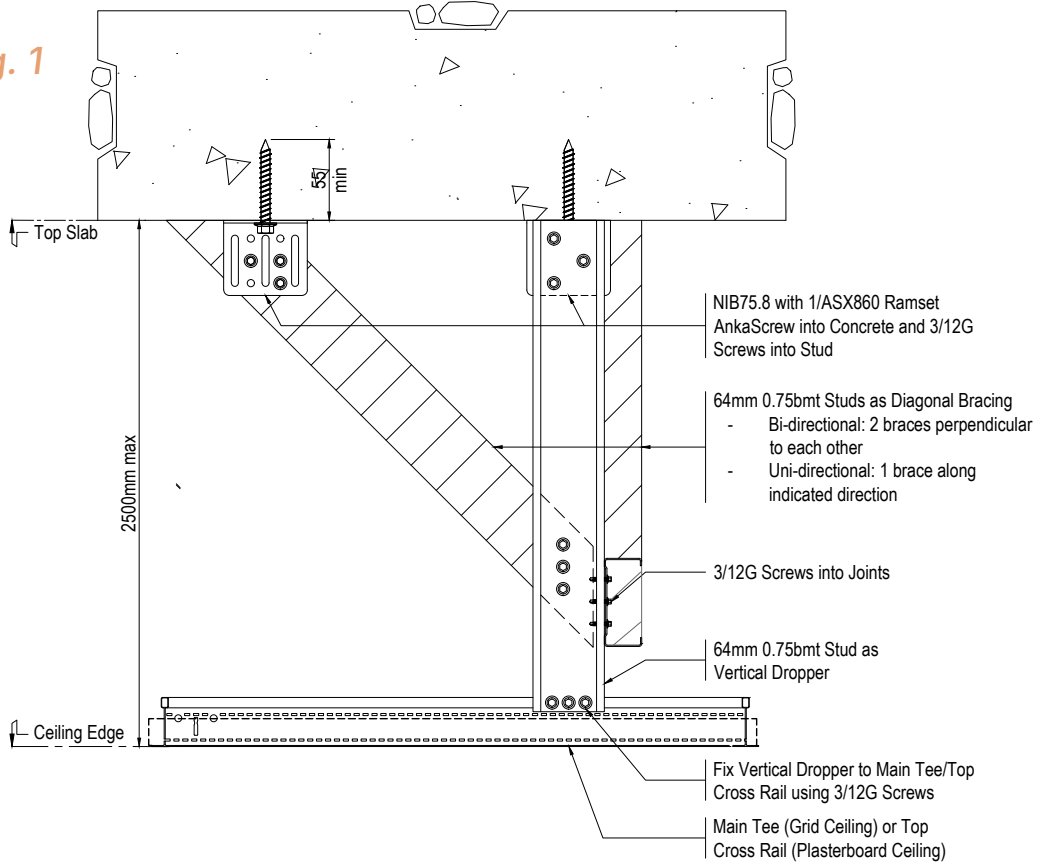

Fig. 2

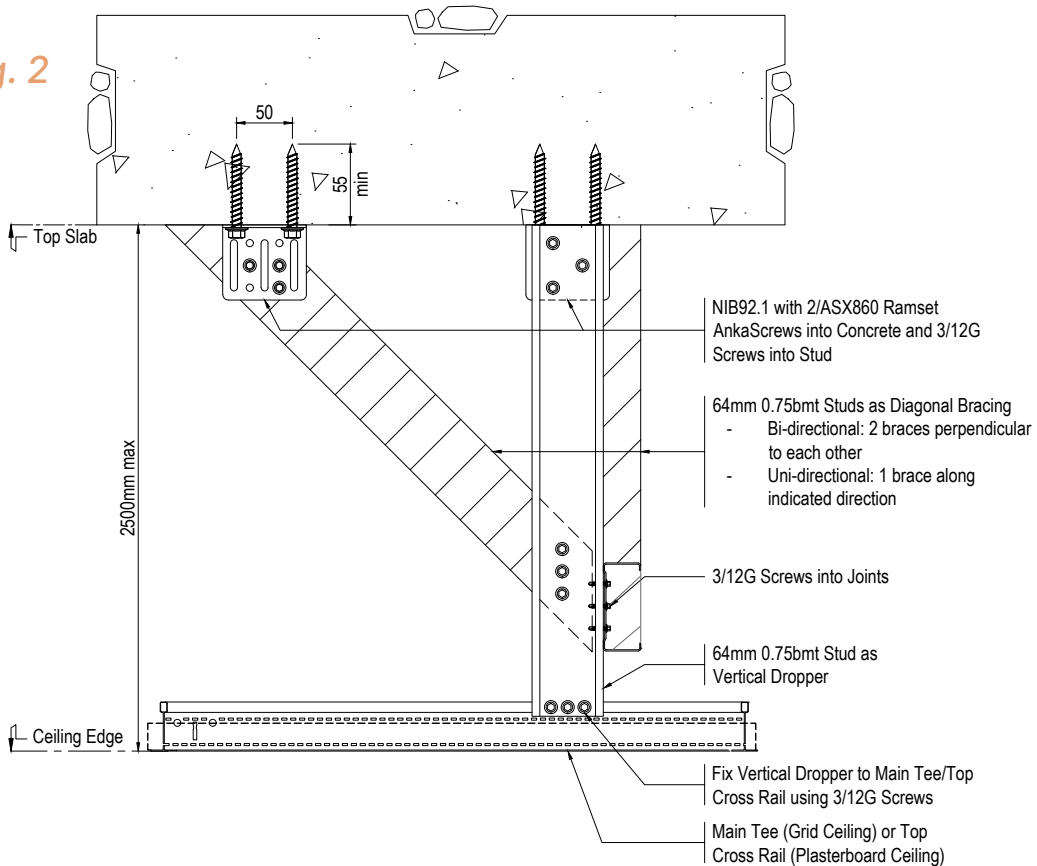

Fig. 3

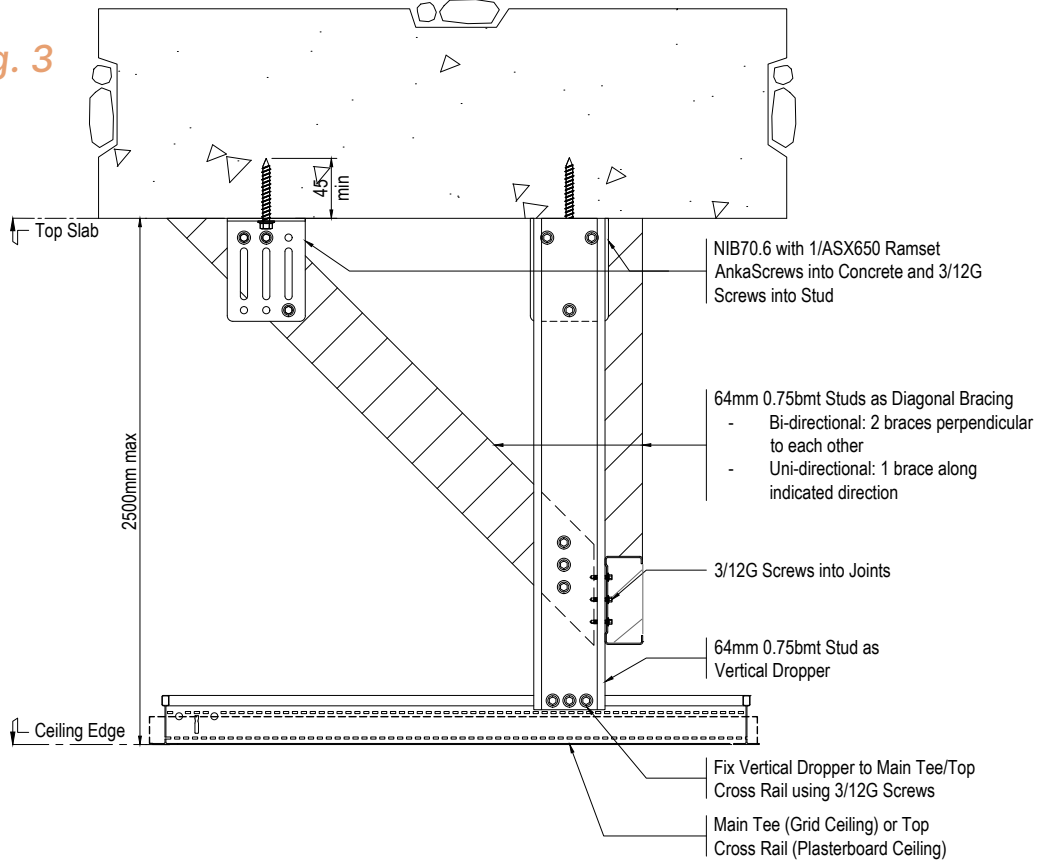

Fig. 4

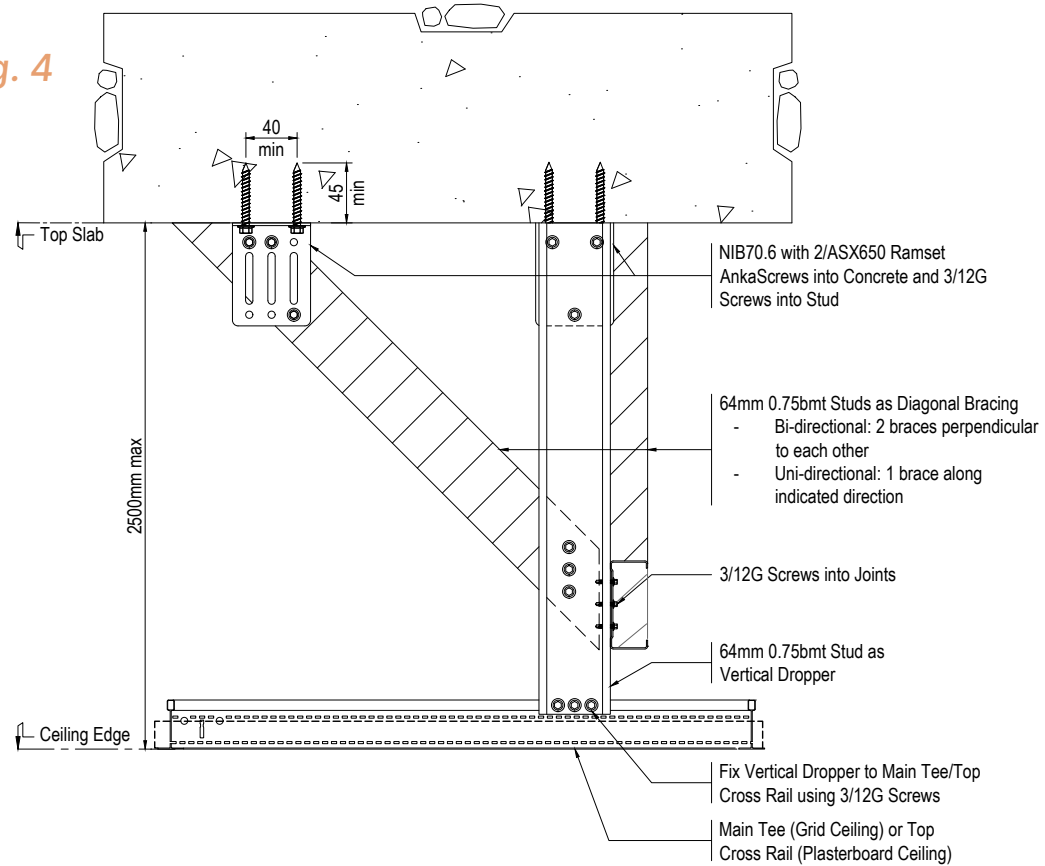

Fig. 5

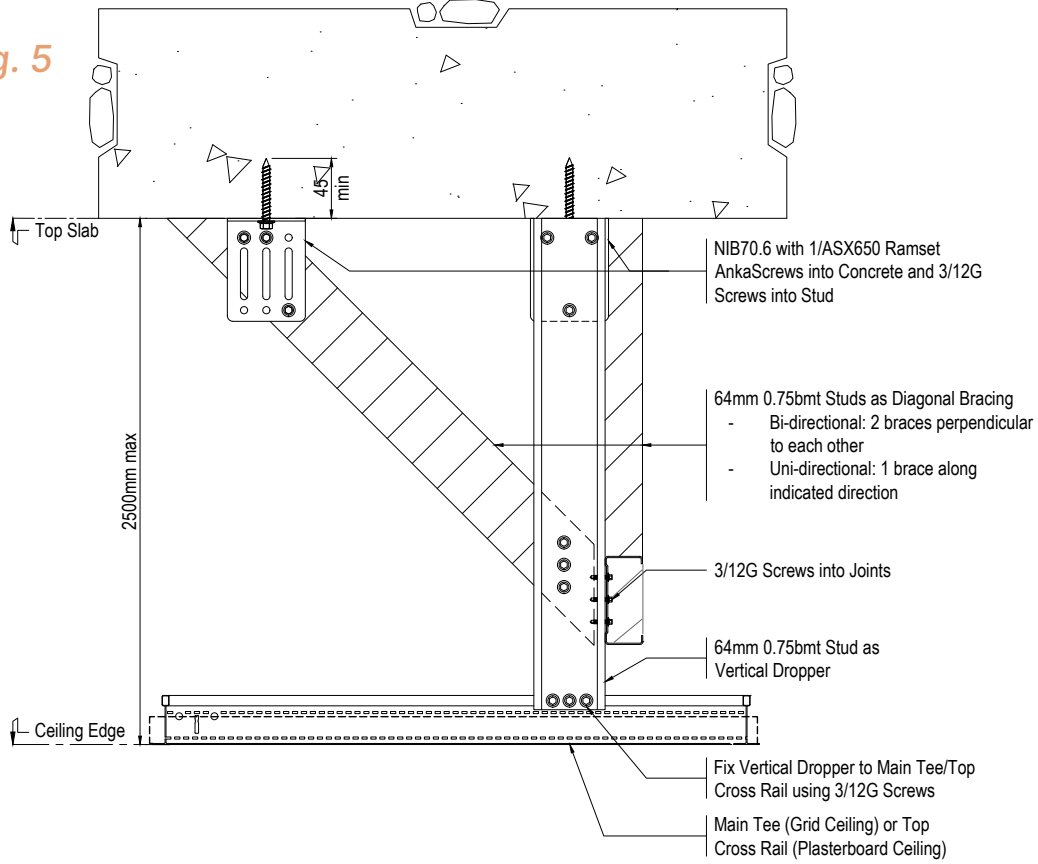
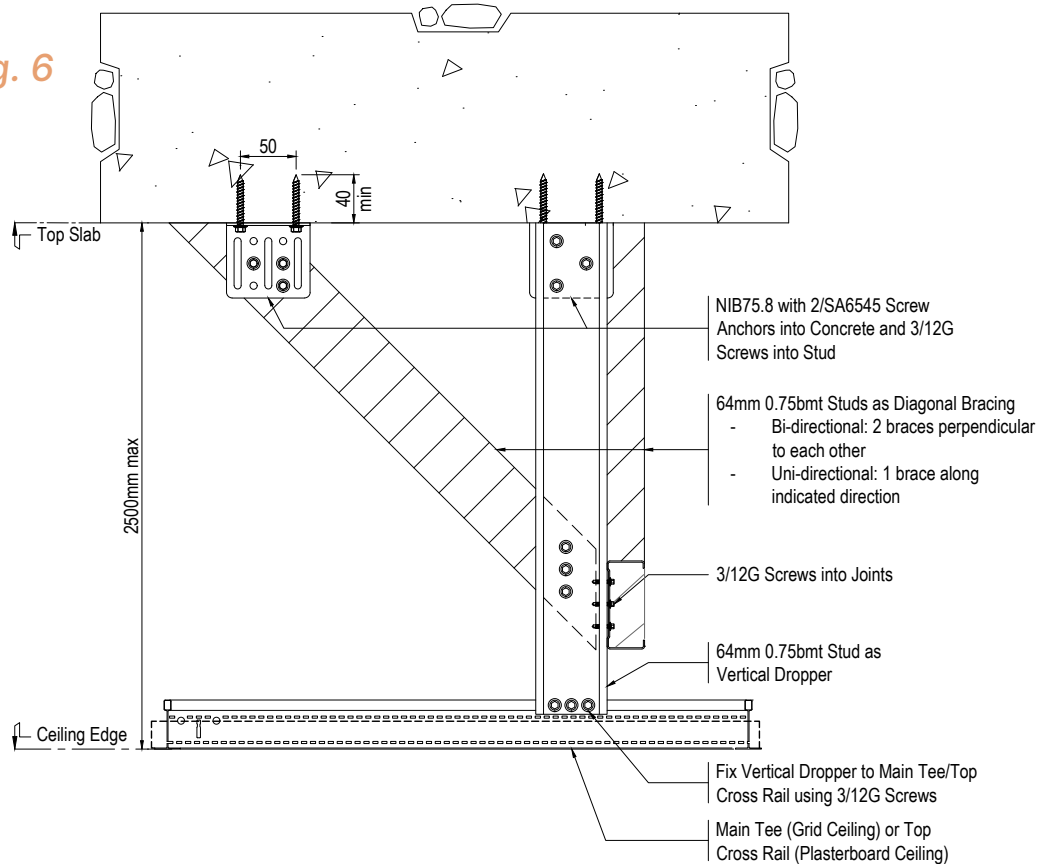



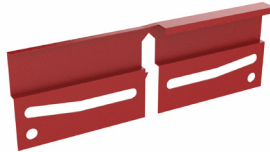



Fig. 6



TRIMS & ACCESSORIES

Perimeter trims and accessories required for seismically stable ceiling installation.

Description	Item No.	
Seismic Aluminium Wall Angle - Plain	SWA-36	
Seismic Aluminium Wall Angle - Shadowline	SWAS-36	
Seismic Roll-in Clip	SRIC	
Seismic Tee Joint Clip	STJC	
Expansion Sleeve to suit 24mm grid	ES24	

INTEGRATION OF SERVICES

Clearances for services within the ceiling plenum should meet the following minimums.

Ceiling hangers and braces are classified as restrained components.

Condition	Horizontal (mm)	Vertical (mm)
Unrestrained to unrestrained	250	25
Unrestrained to restrained	100	25
Restrained to restrained	35	25
Sprinkler head (flexible dropper)	-	-

NOTE: Columns and other penetrations through the ceiling can be considered as restrained "services" within this table as required.

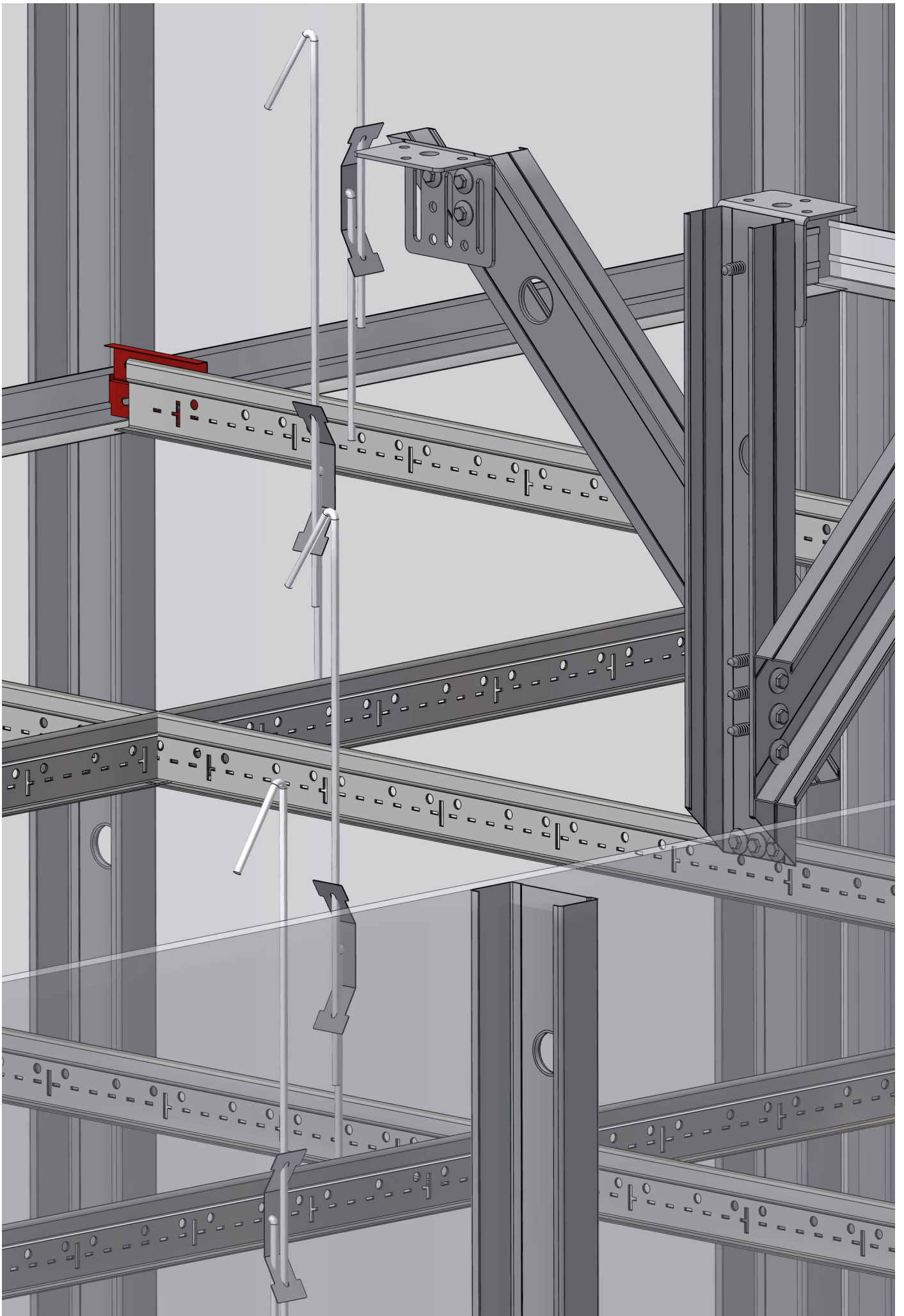

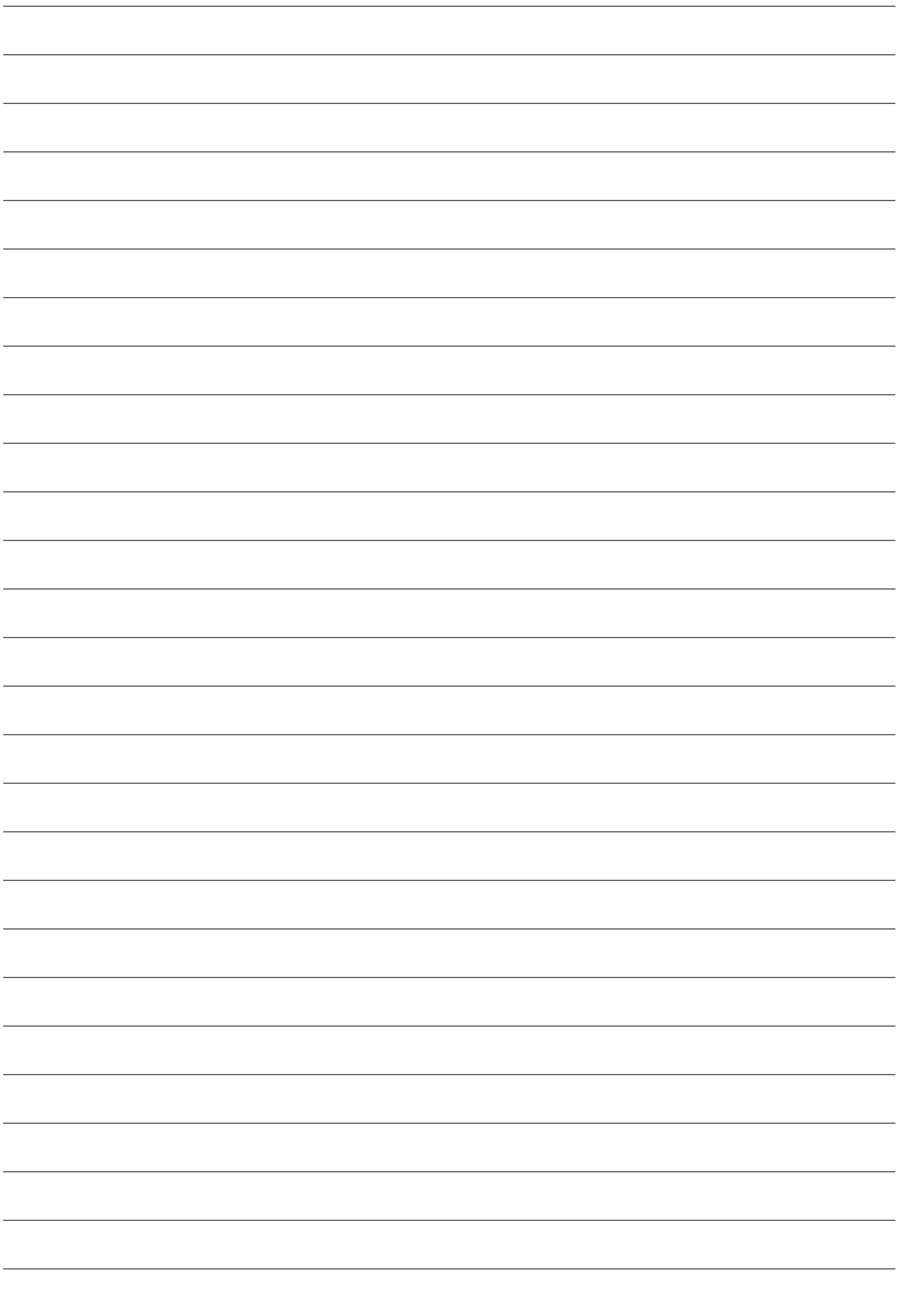

NOTES

NCS NATIONAL CEILING SYSTEMS

